

Article number: 2011321015M20x15A

Description: E+G Holding bushes for lifting pins,
GN 1132-10-15-M20x1.5-A

Measures

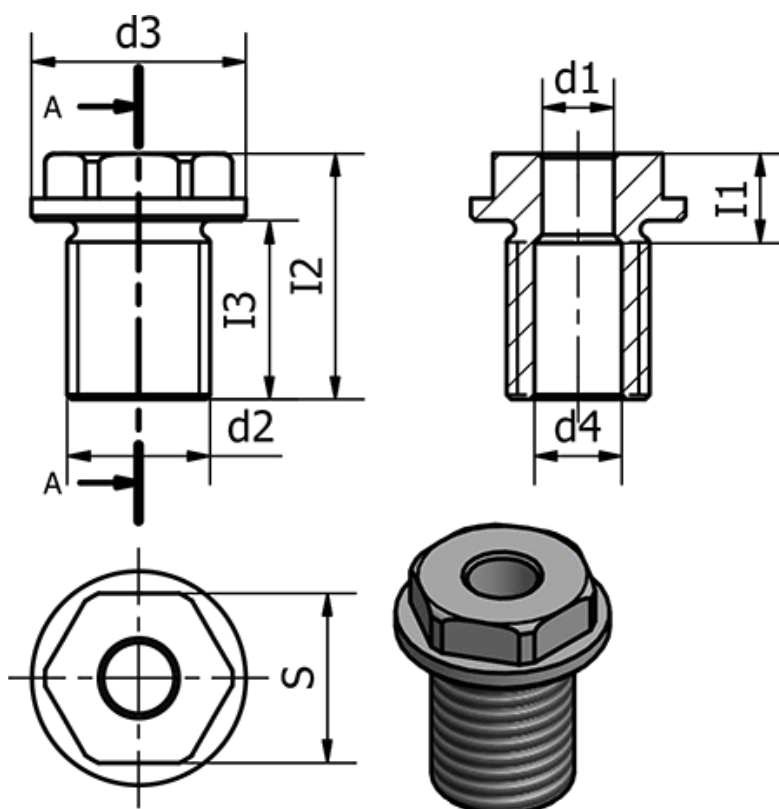

d1 = 10
d2 = M20 x 1,5
d3 = 28
d4 = 12.2
I1 = 15
I2 = 35.5
I3 = 24
s = 24

Tightening torque in Nm = 145